

**KENWOOD**

AUDIO VIDEO STEREO RECEIVER  
**KR-V7050**

---

**INSTRUCTION MANUAL**

KENWOOD CORPORATION

# Introduction

Your choice of this product indicates that you are a devotee to excellence in sound reproduction.

We appreciate your patronage and take pride in the long tradition of quality components that our company represents.

So that you can get the most out of your unit, we suggest that you take the time to read through this manual before you hook up and operate your system. This will acquaint you with operating features and system-connection considerations so that your listening pleasure will be enhanced right from the start. You will notice that in all aspects of planning, engineering, styling, operating convenience and adaptability we have sought to anticipate your needs and desires.

**Keep this manual handy for future reference.**

## For your records

Record the serial number, found on the back of the unit, in the spaces designated on the warranty card, and in the space provided below. Refer to the model and serial numbers whenever you call upon your dealer for information or service on this product.

Model \_\_\_\_\_ Serial Number \_\_\_\_\_

## Unpacking

Unpack the unit carefully and make sure that all accessories are put aside so they will not be lost.

Examine the unit for any possibility of shipping damage. If your unit is damaged or fails to operate, notify your dealer immediately. If your unit was shipped to you directly, notify the shipping company without delay. Only the consignee (the person or company receiving the unit) can file a claim against the carrier for shipping damage.

We recommend that you retain the original carton and packing materials for use should you transport or ship the unit in the future.

## Accessories

FM indoor antenna ..... 1 AM loop antenna ..... 1

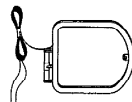

Batteries ("R03" or "AAA") ..... 2 Loop antenna holder ..... 1



AC plug adaptor ..... 1 Remote control unit ..... 1

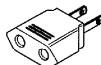

(Except for some areas)

# Contents

Introduction .....	2
▲Before applying power .....	3
▲Safety precautions .....	3
▲IMPORTANT SAFEGUARDS .....	4
System connections .....	6
Connection of audio components .....	6
Setting the SPEAKER IMPEDANCE SELECTOR .....	7
Connection for system control operation .....	10
Connection of video components .....	11
Controls and indicators .....	12
Remote control operation .....	14
Operating instructions .....	17
Basic playback operation .....	17
Operation of LINE STRAIGHT playback .....	19
Ordinary tape recording .....	20
Tape dubbing .....	20
Listening to a broadcast .....	21
Receiving broadcast stations and storing them in memory (preset operation) .....	21

**Caution : Read the pages marked ▲ carefully to ensure safe operation.**

Direct tuning of radio stations .....	22
Receiving a preset station .....	22
Listening to all preset stations in sequence : PRESET CALL .....	22
Operation of video components .....	23
Presence .....	24
Operation of Dolby PRO LOGIC playback .....	26
Dolby PRO LOGIC field adjustment .....	26
Operation of Dolby PRO LOGIC playback .....	27
Dolby 3 STEREO Mode .....	28
Dolby 3 STEREO adjustment .....	28
Dolby 3 STEREO playback .....	28
DSP / DSP LOGIC Presence .....	29
Creating a DSP sound field .....	30
Surround Information Memory .....	31
How to save Surround setup in memory .....	31
How to recall a Surround setup .....	31
In case of difficulty .....	32
▲ Specifications .....	34

# Before applying power

 **Caution: Read this page carefully to ensure safe operation.**

## For the U.S.A. and Canada

### Important!

Units shipped to the U.S.A. and Canada are designed for operation on 120 volts AC only.

**CAUTION:** TO PREVENT ELECTRIC SHOCK DO NOT USE THE AC PLUG WITH AN EXTENSION CORD, RECEPTACLE OR OTHER OUTLET UNLESS THE BLADES CAN BE FULLY INSERTED TO PREVENT BLADE EXPOSURE.

## For Australia and Europe

### Important!

Units shipped to Australia are designed for operation on 240 V AC only.

Units shipped to Europe are designed for operation on 230 V AC only.

## For the United Kingdom

### Important!

Units shipped to the U.K. are designed for operation on 240 volts AC only.

The mains plug must be removed from the wall socket prior to any internal examination.

The wires in this mains lead are coloured in accordance with the following code:

Blue ..... Neutral  
Brown ..... Live

The wires in this mains lead must be connected to the terminals in the plug as follows:

Wire colour	Plug terminal marking
Blue .....	N or Black
Brown .....	L or Red

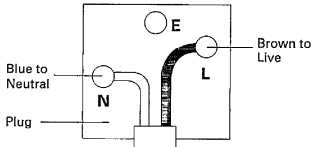

Notes:-

1. If a 13-amp plug is used, this must be fitted with a 13-amp fuse.
2. If a 3-pin plug with earthing contact is used, no wire must be connected to the E terminal.

## For other countries

### Important!

Units shipped to countries other than the above countries are equipped with an AC voltage selector switch on the rear panel. Refer to the following paragraph for the proper setting of this switch.

### AC voltage selection

This unit operates on 110 - 120 or 220 - 240 volts AC. The AC voltage selector switch Type A or Type B on the rear panel is set to the voltage that prevails in the area to which the unit is shipped. Before connecting the power cord to your AC outlet, make sure that the setting position of this switch matches your line voltage. If not, it must be set to your voltage in accordance with the following direction.

### AC voltage selector switch

#### Type A

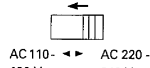

#### Type B

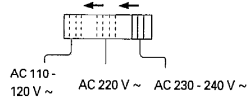





Move switch lever to match your line voltage with a small screwdriver or other pointed tool.

Note:-

Our warranty does not cover damage caused by excessive line voltage due to improper setting of the AC voltage selector switch.

# Safety precautions

**WARNING:** TO PREVENT FIRE OR ELECTRIC SHOCK, DO NOT EXPOSE THIS APPLIANCE TO RAIN OR MOISTURE.

	<p><b>CAUTION</b> RISK OF ELECTRIC SHOCK DO NOT OPEN</p> 	<p>CAUTION: TO REDUCE THE RISK OF ELECTRIC SHOCK, DO NOT REMOVE COVER (OR BACK). NO USER-SERVICEABLE PARTS INSIDE, REFER SERVICING TO QUALIFIED SERVICE PERSONNEL.</p>
	<p>THE LIGHTNING FLASH WITH ARROWHEAD SYMBOL, WITHIN AN EQUILATERAL TRIANGLE, IS INTENDED TO ALERT THE USER TO THE PRESENCE OF UNINSULATED "DANGEROUS VOLTAGE" WITHIN THE PRODUCT'S ENCLOSURE THAT MAY BE OF SUFFICIENT MAGNITUDE TO CONSTITUTE A RISK OF ELECTRIC SHOCK TO PERSONS.</p>	
	<p>THE EXCLAMATION POINT WITHIN AN EQUILATERAL TRIANGLE IS INTENDED TO ALERT THE USER TO THE PRESENCE OF IMPORTANT OPERATING AND MAINTENANCE (SERVICING) INSTRUCTIONS IN THE LITERATURE ACCOMPANYING THE APPLIANCE.</p>	

# IMPORTANT SAFEGUARDS

 **Caution: Read this page carefully to ensure safe operation.**

Please read all of the safety and operating instructions before operating this unit. For best results, follow all warnings placed on the unit and adhere to the operating and use instructions. These safety and operating instructions should be retained for future reference.

**1. Power sources** – The unit should be connected to a power supply only of the type described in the operating instructions or as marked on the appliance.

**2. Power-cord protection** – Power-supply cords should be routed so that they are not likely to be walked on or pinched by items placed upon or against them, pay particular attention to cords at plugs, convenience receptacles, and the point where they exit from the unit.

Never pull or stretch the cord.

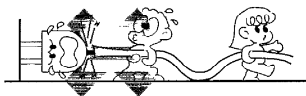

**3. Grounding or polarization** – The precautions should be taken so that the grounding or polarization means of this unit is not defeated.

**4. Ventilation** – The unit should be situated so that its location or position does not interfere with its proper ventilation.

To maintain good ventilation, do not put records or a table-cloth on the unit. Place the unit at least 10 cm away from the walls.

Do not use the unit on a bed, sofa, rug or similar surface that may block the ventilation openings.

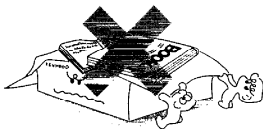

**5. Water and moisture** – The unit should not be used near water - for example, near a bathtub, washbowl, kitchen sink, laundry tub, in a wet basement, or near a swimming pool, etc.

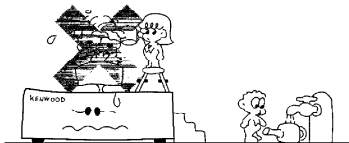

**6. Temperature** – The unit may not function properly if used at extremely low, or freezing temperatures. The ideal ambient temperature is above +5°C (41°F).

**7. Heat** – The unit should be situated away from heat sources such as radiators, heat registers, stoves, or other units (including amplifiers) that produce heat.

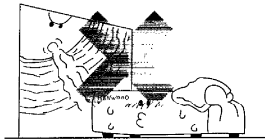

**8. Electric shock** – Care should be taken so that objects do not fall and liquid is not spilled into the enclosure through openings. If a metal object, such as a hair pin or a needle, comes into contact with the inside of this unit, a dangerous electric shock may result. For families with children, never permit children to put anything, especially metal, inside this unit.

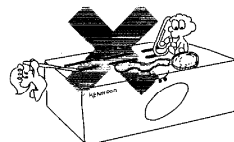

**9. Enclosure removal** – Never remove the enclosure. If the internal parts are touched accidentally, a serious electric shock might occur.

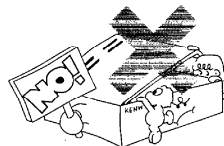

**10. Magnetic fields** – Keep the unit away from sources of magnetic fields such as TV sets, speaker systems, radios, motorized toys or magnetized objects.

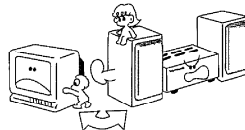

**11. Cleaning** – Do not use volatile solvents such as alcohol, paint thinner, gasoline, or benzine, etc. to clean the cabinet. Use a clean dry cloth.

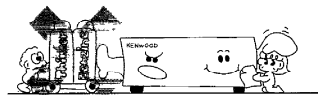

**12. Carts and stands** – An appliance and cart combination should be moved with care. Quick stops, excessive force, and uneven surfaces may cause the appliance and cart combination to overturn.



**13. Nonuse periods** – The power cord of the unit should be unplugged from the outlet when left unused for a long period of time.

**14. Abnormal smell** – If an abnormal smell or smoke is detected, immediately turn the power OFF and pull out the power cord. Contact your dealer or nearest service center.

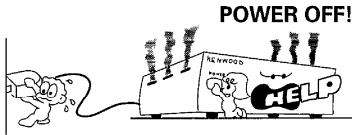

**15. Damage requiring service** – The unit should be serviced by qualified service personnel when:

- A.** The power-supply cord or the plug has been damaged; or
- B.** Objects have fallen, or liquid has been spilled into the unit; or
- C.** The unit has been exposed to rain; or
- D.** The unit does not appear to operate normally or exhibits a marked change in performance; or
- E.** The unit has been dropped, or the enclosure damaged.

**16. Servicing** – The user should not attempt to service the unit beyond that described in the operating instructions. All other servicing should be referred to qualified service personnel.

**17. Outdoor antenna grounding** – If an outside antenna is connected to the receiver, be sure the antenna system is grounded so as to provide some protection against voltage surges and built up static charges. Section 810 of the National Electrical Code, ANSI/NFPA 70, provides information with respect to proper grounding of the mast and supporting structure, grounding of the lead-in wire to an antenna discharge unit, size of grounding conductors, location of antenna-discharge unit, connection to grounding electrodes, and requirements for the grounding electrode. See Figure.

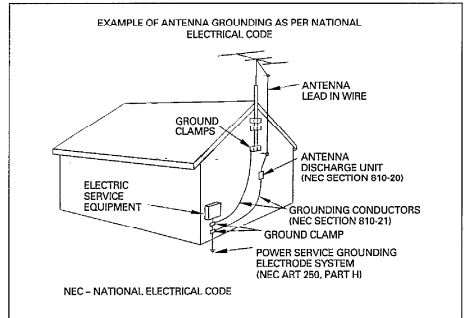

**18. Power lines** – An outdoor antenna should be located away from power lines.

**19. AC outlets** – Do not connect other audio equipment with a power consumption larger than that specified to the AC outlet on the rear panel. Never connect other electrical units, such as an iron or toaster, to it to prevent fire or electric shock.

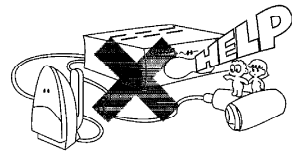

**Notes:**

1. Item 3 is not required except for grounded or polarized equipment.
2. Item 17 and 18 are not required except for units provided with antenna terminals.
3. Item 17 complies with UL in the U.S.A.

# System connections

Make connections as shown in the diagram below. When connecting the related system components, refer also to the instruction manuals of the related components.  
Do not plug in the power lead until all connections are completed.

## ■ Connection of audio components

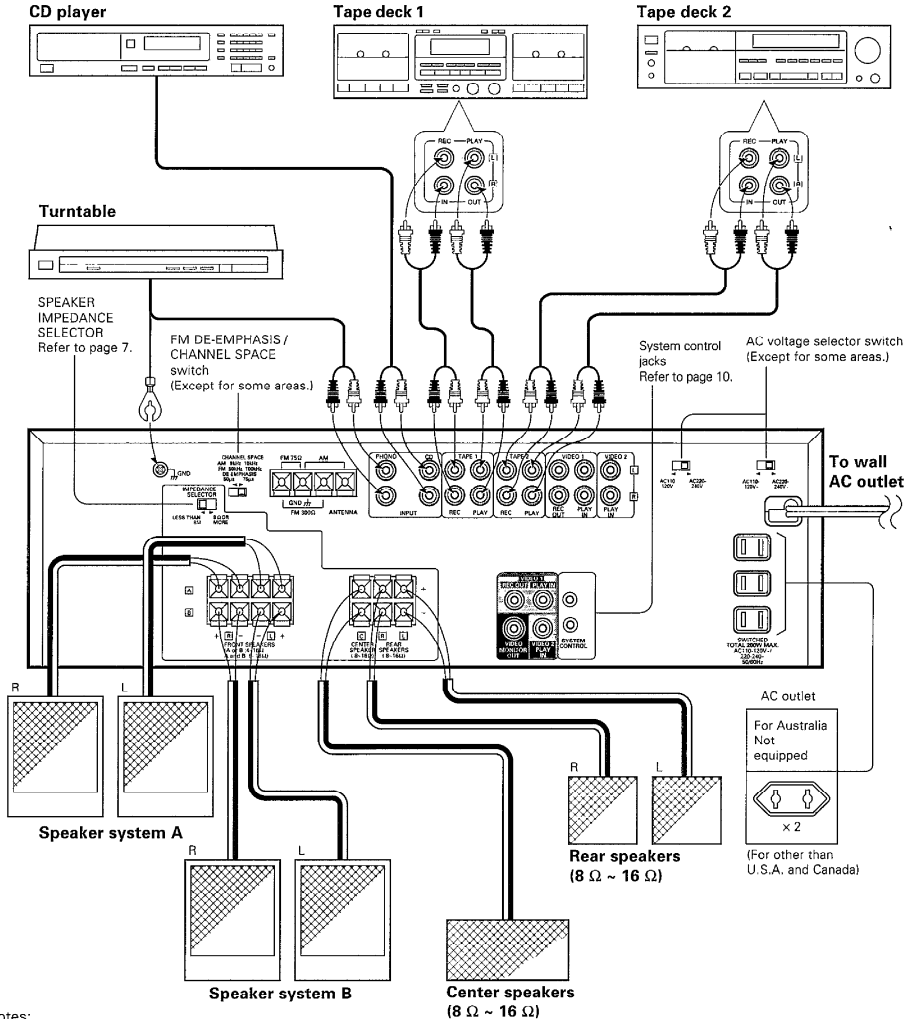

Notes:

1. Connect all cords firmly. If connections are loose, there could be loss of sound or noise produced.
2. Do not connect up a power source which is larger than that indicated on the socket at the rear of the unit.
3. When plugging and unplugging connection cords, be sure to first remove the power cord from the AC outlet. Plugging / unplugging connection cords without removal of the power cord can cause malfunctions or damage to the unit.
4. Never short-circuit the + and - speaker cords.
5. If the left and right speakers are connected inversely or if the speaker cords are connected with reversed polarity, the sound becomes unnatural with ambiguous acoustic image positioning. Be sure to connect the speakers and speaker cords correctly.

## ■ Connection of speaker terminals

① Push lever.



② Insert cord.

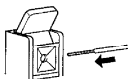

③ Lock lever.



## ■ Setting the SPEAKER IMPEDANCE SELECTOR



According to the impedance of the speakers used, set the SPEAKER IMPEDANCE SELECTOR on the rear panel as shown in the table.

- During speaker system connection and operation of the SPEAKER IMPEDANCE SELECTOR, set the POWER switch to OFF.

① When Surround speakers are connected

② When Surround speakers are not connected

Usable speaker impedance	Selector position	Usable speaker impedance	Selector position
A or B speakers 4 Ω - 6 Ω	<p>IMPEDANCE SELECTOR</p>	A or B speakers 4 Ω - 6 Ω	<p>IMPEDANCE SELECTOR</p>
Center speaker 8 Ω - 16 Ω			
Rear speakers 8 Ω - 16 Ω			
A or B speakers 8 Ω - 16 Ω	<p>IMPEDANCE SELECTOR</p>	A or B speakers 8 Ω - 16 Ω or A and B speakers 8 Ω - 16 Ω	<p>IMPEDANCE SELECTOR</p>
Center speaker 8 Ω - 16 Ω			
Rear speaker 8 Ω - 16 Ω			

■ AM loop antenna connection

The supplied antenna is for indoor use. Place it as far as possible from the main system, TV set, speaker cords and power cord, and set it to a direction which provides the best reception.

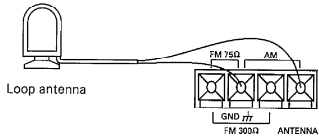

■ AM outdoor antenna connection

If the reception is poor when the AM loop antenna is used, distribute a vinyl-coated wire of more than 6 meters outdoors, without disconnecting the loop antenna.

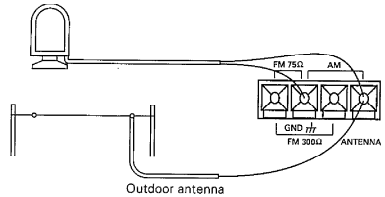

■ FM indoor antenna connection

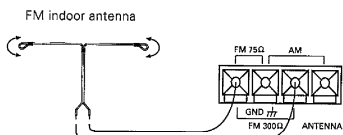

- ① Find the position that provides best reception.
- ② Fix two ends.

■ FM outdoor antenna connection

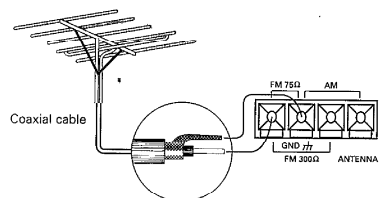



## FM DE-EMPHASIS/CHANNEL SPACE switch (Except for some areas)

The FM DE-EMPHASIS/ CHANNEL SPACE switch on the rear panel is set to the correct setting that prevails in the area to which the unit is shipped. However, if the FM DE-EMPHASIS/ CHANNEL SPACE setting is not matched to the area where the unit is to be used; for instance, when you move from area 1 to area 2 or vice versa, desired reception of AM/ FM broadcasts is not expected. In this case, change the FM DE-EMPHASIS/ CHANNEL SPACE setting in accordance with the area corresponding to the table. The FM DE-EMPHASIS is switched over at the same time.

	Area	CHANNEL SPACE freq.	FM DE-EMPHASIS
1.	U.S.A., Canada and South American countries	FM: 100kHz AM: 10kHz	75 $\mu$ s
2.	Other countries	FM: 50kHz AM: 9kHz	50 $\mu$ s

- When changing the setting of the FM DE-EMPHASIS/ CHANNEL SPACE switch, first disconnect the power cord, then reset the channel space switch, connect the power cord again, and turn the power on.

CHANNEL SPACE  
AM 9kHz 10kHz  
FM 50kHz 100kHz  
DE EMPHASIS  
50 $\mu$ s 75 $\mu$ s



## ■ Connection for system control operation

Using the system control cords provided with KENWOOD system component models, make connections as shown below.

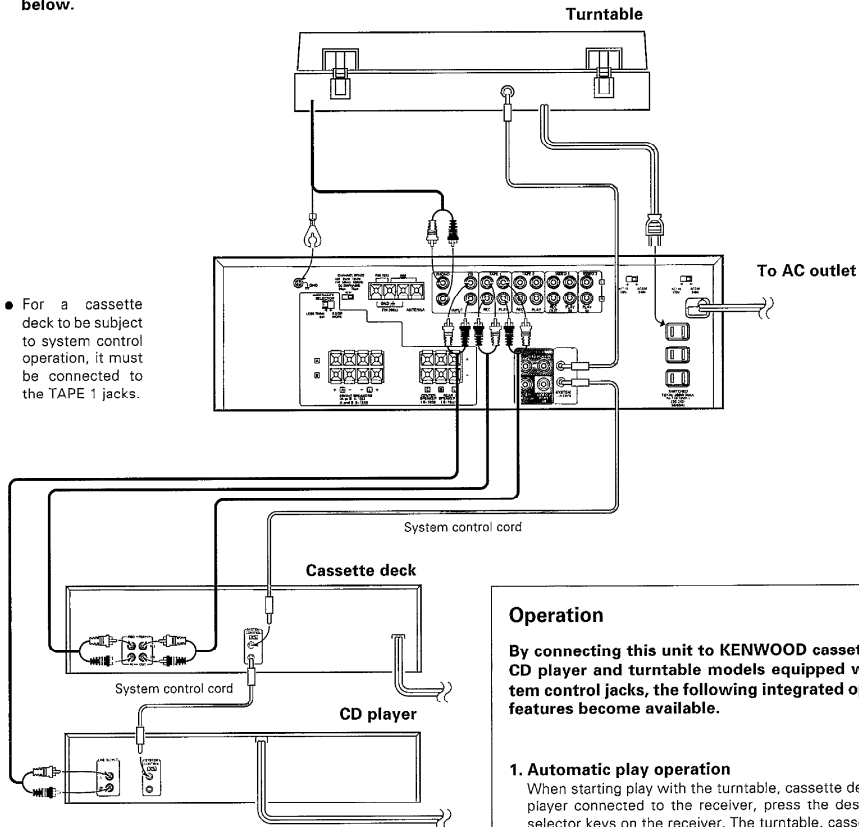

- For a cassette deck to be subject to system control operation, it must be connected to the TAPE 1 jacks.

### System control connection

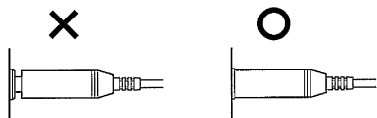

- Be sure to insert the system control cord plugs fully into the SYSTEM CONTROL terminals.
- If the system control cord and audio cords are not connected properly, the automatic system governing remote control and system functions will not operate.

### Operation

By connecting this unit to KENWOOD cassette deck, CD player and turntable models equipped with system control jacks, the following integrated operation features become available.

#### 1. Automatic play operation

When starting play with the turntable, cassette deck, or CD player connected to the receiver, press the desired input selector keys on the receiver. The turntable, cassette deck, or CD player will automatically enter play mode.

In the same way, pressing the Play key of the turntable, cassette deck, or CD player will automatically switch the input selector on the receiver to the component on which the Play key is pressed.

#### 2. Synchro recording

To record the sound from the CD player or turntable onto a tape with the cassette deck, press the CD or PHONO of the input selector keys and load a CD or record. Set the cassette deck to rec pause mode, then press the Play (start) key of the CD player or turntable. The cassette deck will start recording automatically, synchronized with the CD player or turntable starting play.

#### 3. Remote control

The remote control unit provided with this unit, to which a KENWOOD system, cassette deck, or CD player is connected, is equipped with related control keys. The related components can be controlled using these keys.

## ■ Connection of video components

For the connections and operations, also read carefully the instruction manuals supplied with the video components to be connected.

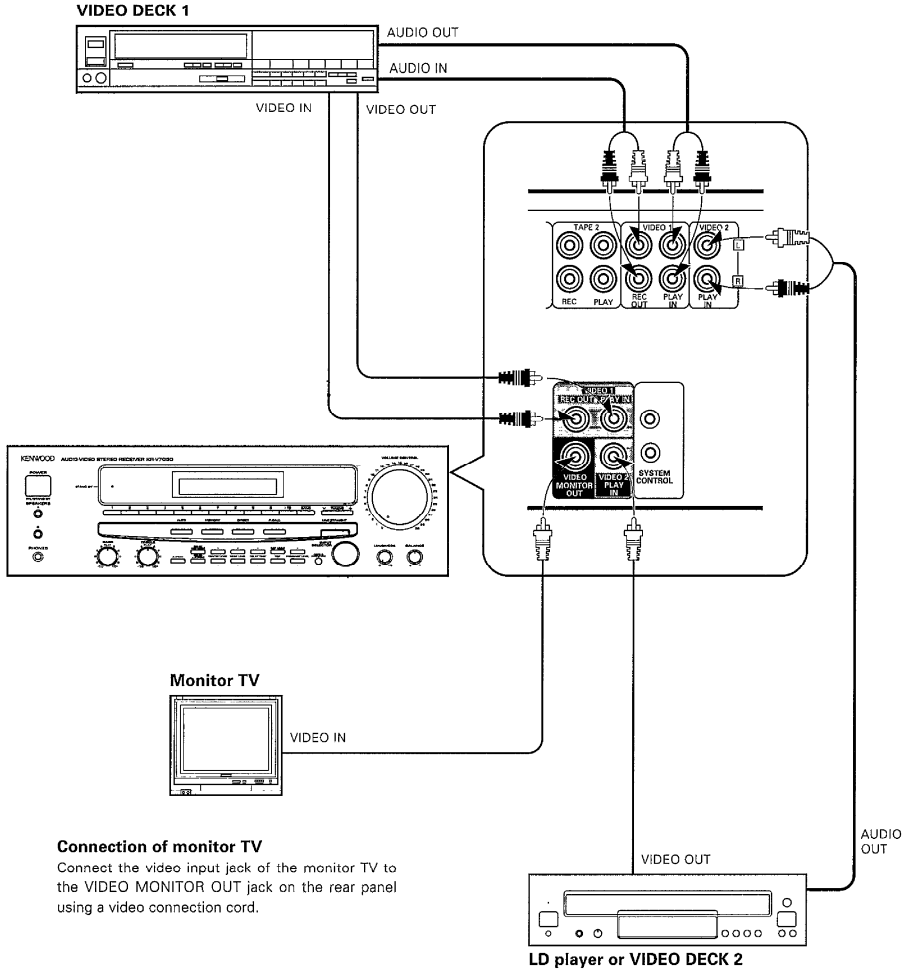

### Connection of monitor TV

Connect the video input jack of the monitor TV to the VIDEO MONITOR OUT jack on the rear panel using a video connection cord.

# Controls and indicators

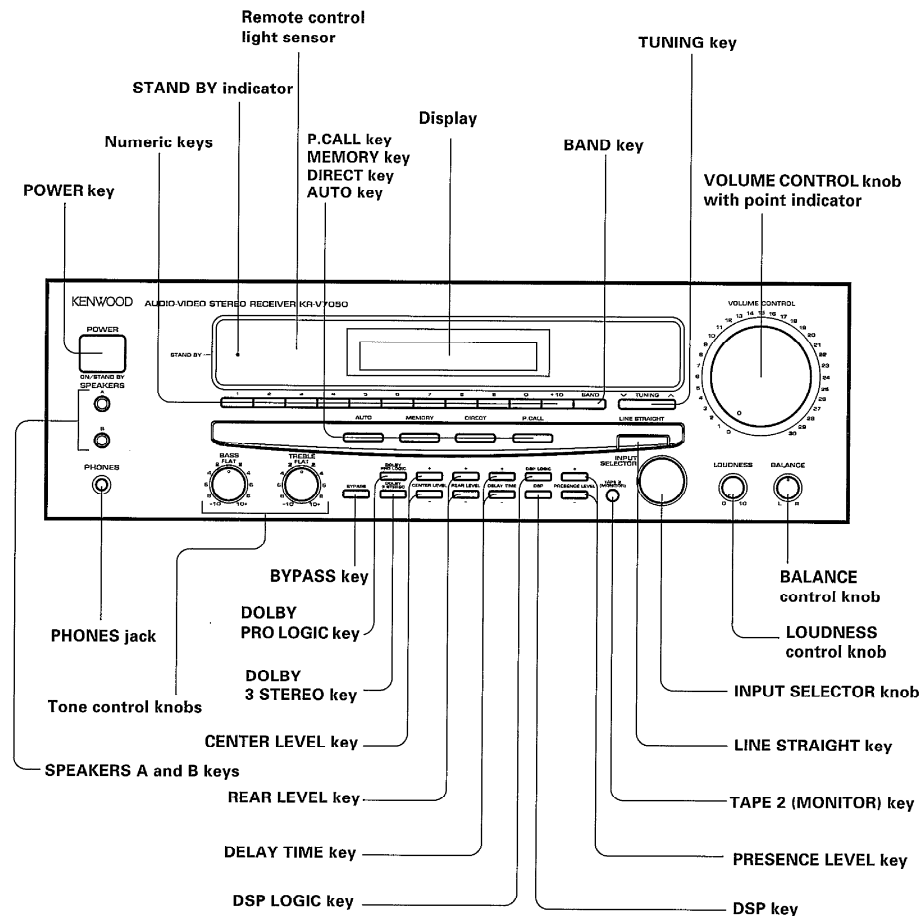

## SPEAKERS A and B keys

- A, B OFF** — This position silences all speakers to permit private use of headphones.
- A ON** — Activates speakers connected to the SPEAKERS A terminals on the rear panel.
- B ON** — Activates the speakers connected to the SPEAKERS B terminals on the rear panel.
- A, B ON** — Activates the speakers connected to the SPEAKERS A and B terminals simultaneously.

- If you press the DOLBY PRO LOGIC key, DOLBY 3 STEREO key, DSP LOGIC key or DSP key when both the A and B SPEAKERS switches are ON, the unit will automatically switch to A so that sound is heard only from the A speakers. Pressing the B key at this time will switch the sound so that it is heard from the B speakers only.

# Display

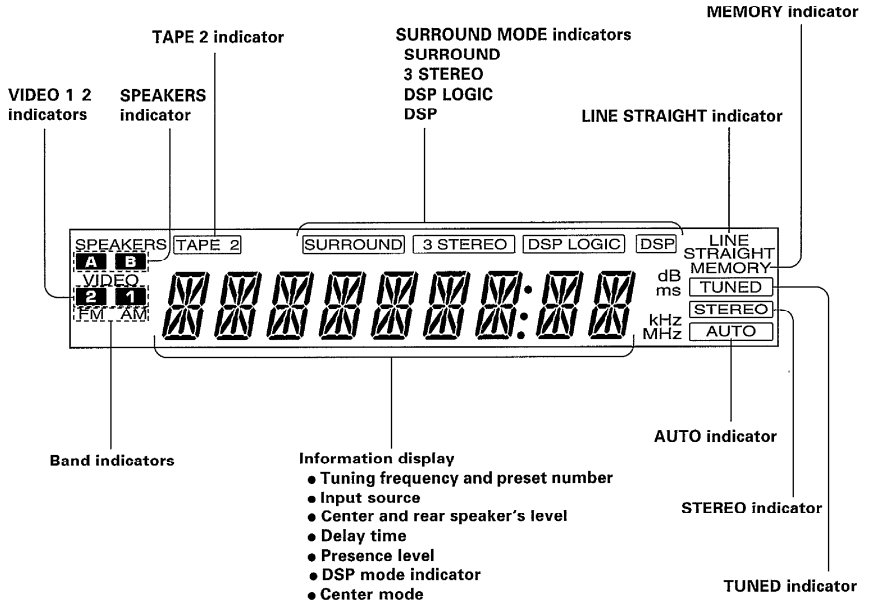

## STAND BY mode of POWER key

When the power cord of this system is plugged into an AC outlet, the STAND BY indicator lights up regardless of the ON / OFF setting of the POWER key. This indicates that a small amount of current is being supplied to the unit to back up the memory contents. This mode is referred to as the Stand By mode. While the STAND BY indicator is lit, the power of the system can be switched ON / OFF from the remote control unit.

# Remote control operation

In addition to the remote control of the receiver unit, the provided remote control unit can control a KENWOOD cassette tape deck, CD player, turntable, etc., connected via the KENWOOD system control cords.

## ■ Loading batteries

### 1 Remove the cover.

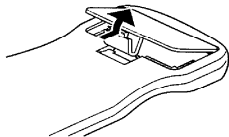

- While gently pressing the cover located on the rear of the remote control unit, slide it in the direction of the arrow.

### 2 Insert batteries.

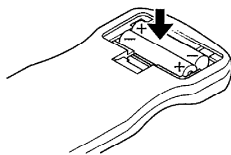

- Make sure that the batteries are inserted as indicated with the polarity marking on the bottom.

#### Notes:

The batteries provided are to be used for checking the remote control operations. Their service life may be short.

### 3 Close the cover.

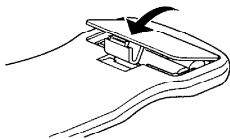

## ■ Operating range of the remote control unit

The normal operating range may change depending on temperature, humidity, and other environmental conditions, but it is roughly specified as shown in the figure.

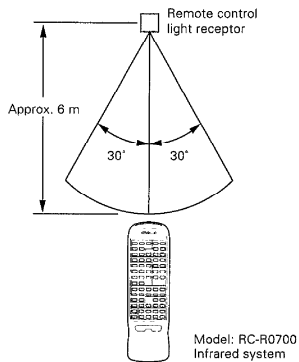

#### Note:

1. If two or more remote control operation keys are to be pressed successively, press each key securely and leave an interval of more than 1 second between presses. Pressing a key immediately after pressing another key may cause malfunction.
2. Malfunction may occur in case direct sunlight or the light of a high-frequency lighting fluorescent lamp enters the remote control light receptor. In such a case, change the installation position of the unit so that the malfunction does not occur.

## ■ Basic operation keys

**DISC key**  
When a CD player with a multi-disc magazine is used, functions as the disc selector. Every press changes the disc number.

**Numeric keys**  
When the CD input is selected, function as the numeric keys of the CD player.  
When the TUNER input is selected, function as the numeric keys of the tuner.  
How to enter numbers:  
  
To enter 23 - Press **[+10]** twice then **[3]** once.  
To enter 40 - Press **[+10]** four times then **[0]** once.

**MUTE key**  
Press to drop the volume temporarily.  
The volume indicator on the VOLUME CONTROL on the main unit flashes during muting.

**POWER key**  
Press to turn the power of the unit ON / OFF.

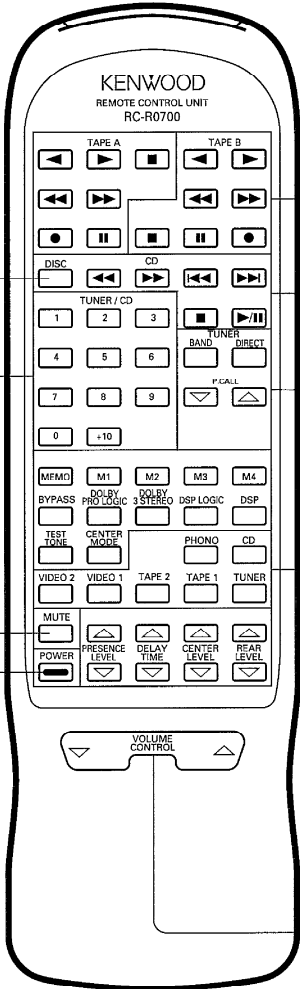

**Tape deck operation keys**  
The TAPE A and TAPE B keys allow to control the operations of tape decks A and B respectively.

**CD player operation keys**

**Tuner operation keys**  
BAND - Press to select the broadcast band (AM or FM).  
P.CALL - Press to recall the preset stations in the upward or downward sequence.  
DIRECT - Use together with the numeric keys to recall a station directly.

**Input selector keys**  
Press one of these keys to select an input source.

**VOLUME CONTROL key**  
Press to control the volume.  
During control operation, the VOLUME CONTROL knob on the main unit rotates and the indicator on it flashes rapidly.

## Remote control operation

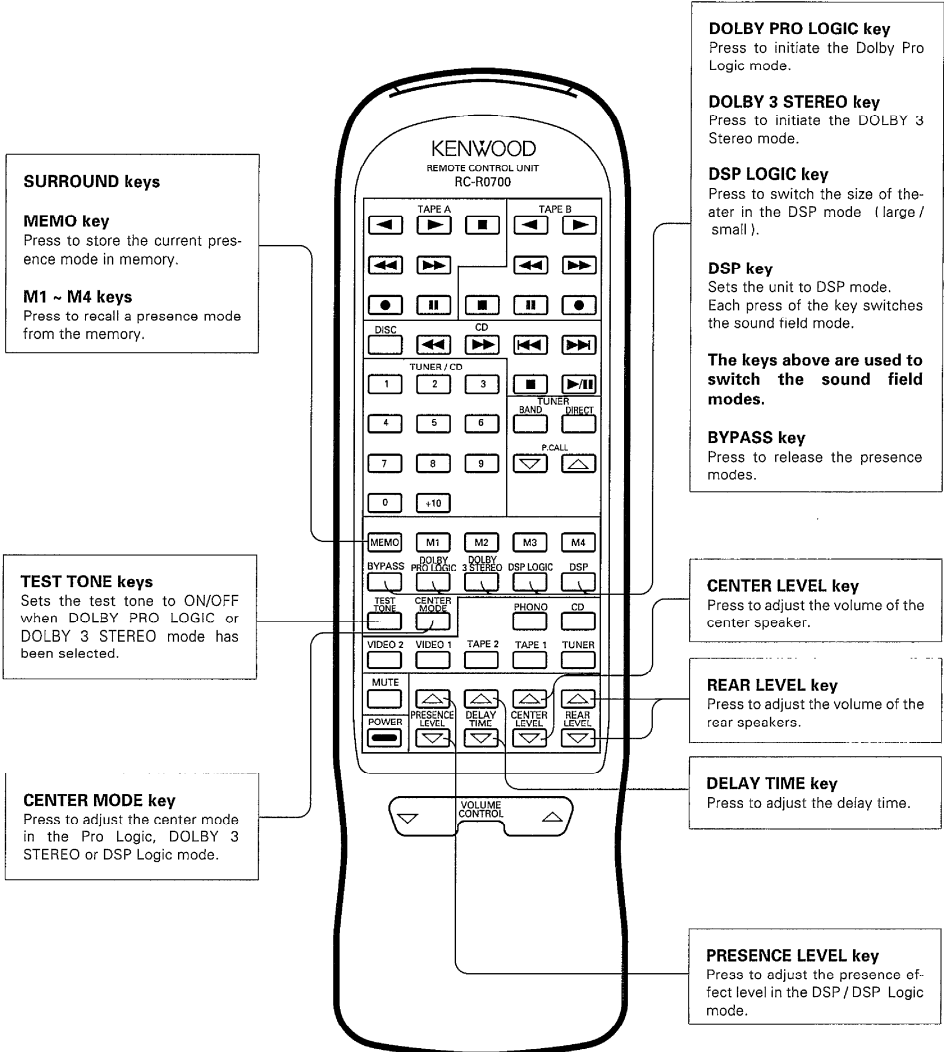

### SURROUND keys

#### MEMO key

Press to store the current presence mode in memory.

#### M1 ~ M4 keys

Press to recall a presence mode from the memory.

### TEST TONE keys

Sets the test tone to ON/OFF when DOLBY PRO LOGIC or DOLBY 3 STEREO mode has been selected.

### CENTER MODE key

Press to adjust the center mode in the Pro Logic, DOLBY 3 STEREO or DSP Logic mode.

### DOLBY PRO LOGIC key

Press to initiate the Dolby Pro Logic mode.

### DOLBY 3 STEREO key

Press to initiate the DOLBY 3 Stereo mode.

### DSP LOGIC key

Press to switch the size of theater in the DSP mode (large / small).

### DSP key

Sets the unit to DSP mode. Each press of the key switches the sound field mode.

**The keys above are used to switch the sound field modes.**

### BYPASS key

Press to release the presence modes.

### CENTER LEVEL key

Press to adjust the volume of the center speaker.

### REAR LEVEL key

Press to adjust the volume of the rear speakers.

### DELAY TIME key

Press to adjust the delay time.

### PRESENCE LEVEL key

Press to adjust the presence effect level in the DSP / DSP Logic mode.



# Operating instructions

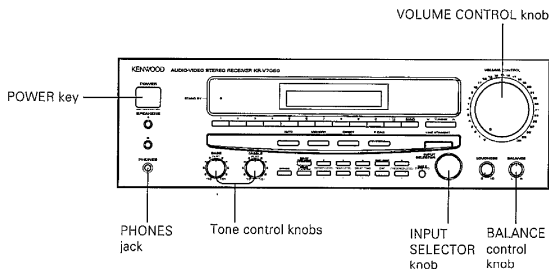

## ■ Basic playback operation

### 1 Press the POWER key to ON.



Main unit



Remote control unit

### 2 Select an input source.

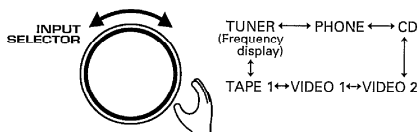

- The source name characters appear on the display.

CD

- When the cassette deck, CD player and turntable are connected via the system control cord, any of these source components starts to be played automatically when the corresponding input is selected.

### 3 Play the source component.

Source : CD  
Tape  
etc.

### 4 Adjust the volume.

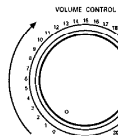

Main unit

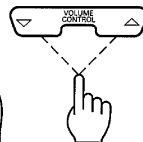

Remote control unit

- When the volume is adjusted from the remote control unit, the VOLUME CONTROL knob on the main unit rotates while the point indicator is blinking.

### 5 Adjust the left and right volume balance.

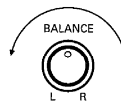

### 6 Adjust the tone.

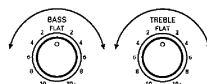

Adjusts the low frequencies

Adjusts the high frequencies.

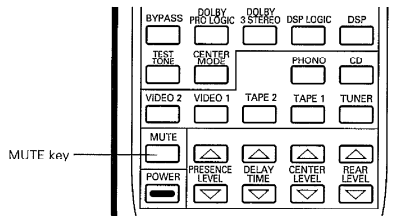

## ■ To mute the sound temporarily

Remote control unit only

Press the MUTE key.

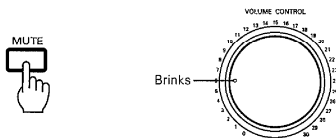

- Pressing the key again resumes the previous volume.

## LOUDNESS control

Listening at high volume allows to enjoy dynamic sound, but human ears tend to feel low frequencies insufficient when listening at low volume. When the VOLUME CONTROL is set to a low position, the insufficiency of low frequencies felt by human ears can be compensated by turning the LOUDNESS control clockwise.

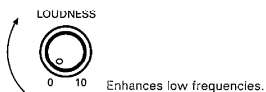

- The effect of LOUDNESS control is less sensible if the VOLUME CONTROL is set to the center position or above.

## ■ Listening with headphones

**1** Set the SPEAKER switch to OFF.

**2** Plug the headphones into the PHONES jack.

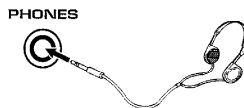

- Set the A and B SPEAKERS switches to OFF.

**3** Adjust the volume.

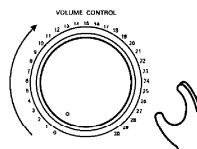

- Turn the volume all the way down before unplugging the headphones.

### Notes:

1. When TAPE 2 is ON, you cannot listen to the source selected by the input select knob. To listen to the selected source, set TAPE 2 to OFF.
2. Even if the power cord is unplugged, the currently selected source is stored in memory for several days. After this period elapses, however, the source is automatically switched to TUNER.

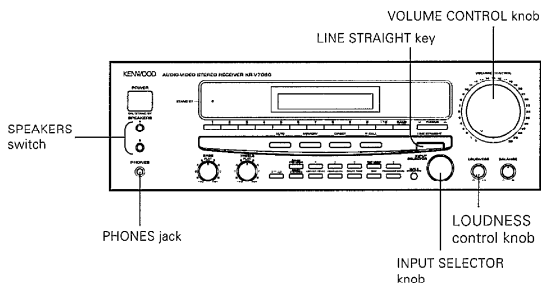

## ■ Operation of LINE STRAIGHT playback

This function lets you enjoy high-quality sound direct from the source.

### 1 Select an input source.

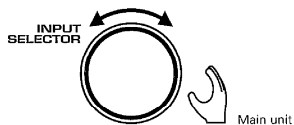

### 2 Press the LINE STRAIGHT key.



### 3 Play the input source.

### To cancel the LINE STRAIGHT playback

Press the LINE STRAIGHT key again.



#### Notes:

1. During LINE STRAIGHT playback, the tone controls do not function.
2. If the DSP, DSP LOGIC, DOLBY 3 STEREO or DOLBY PRO LOGIC key is pressed, the LINE STRAIGHT playback function will be cancelled.

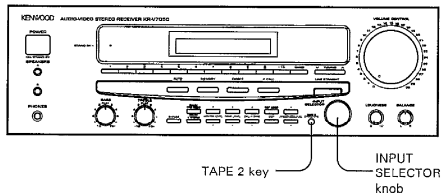

## ■ Ordinary tape recording

### 1 Select the source to be recorded.

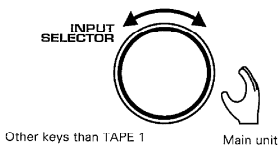

### 2 Set cassette deck in the record-pause mode.



Record-pause mode.

### 3 Play the source component to be recorded, and start recording it on the cassette deck.

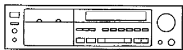

Recording starts.

## ■ Tape dubbing

### TAPE 1 → TAPE 2

- Play the cassette deck connected to TAPE 1 and record on the cassette deck connected to TAPE 2.

### TAPE 2 → TAPE 1

### 1 Press the TAPE 2 key.



### 2 Select a source other than TAPE 1.

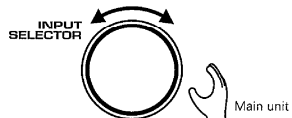

### 3 Play cassette deck 2 and start recording on cassette deck 1.

#### Note:

For the tape-to-tape dubbing procedure using a double-deck type cassette deck, please read the instruction manual provided with the double-deck type cassette deck.

# Listening to a broadcast

## ■ Receiving broadcast stations and storing them in memory (preset operation)

### 1 Select the TUNER input with the input selector.

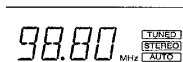
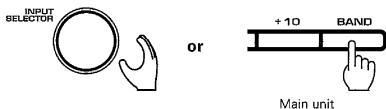

- Previous reception mode is resumed.
- Pressing the BAND key also set the unit to tuner mode.

### 2 Select the broadcast band (FM, AM).

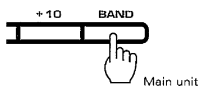

- Each time the BAND key is pressed, the reception band changes between FM and AM.

### 3 Enter the AUTO tuning mode.

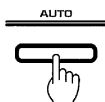
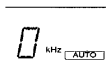

- The indicator goes on (auto) and off (manual) alternately every time the key is pressed. Normally, select the auto tuning mode.

When AUTO is ON: The stereo / monaural is switched automatically according to the station.

When AUTO is OFF: Monaural reception is forced. Set to this position when receiving stations with weak waves.

### 4 Tune a desired station.

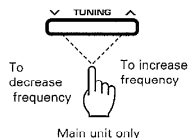
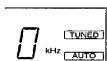

- The TUNED indicator lights up when a station is received.
- When the TUNING UP key is pressed, the frequency increases.
- When the TUNING DOWN key is pressed, the frequency decreases.
- Use manual tuning mode in case the radio wave is weak and noisy. At this time, the stereo FM broadcast is received in monaural mode.

#### Auto tuning mode

Press once. (Tuning stops automatically when a station is received.)

#### Manual tuning mode

Press repeatedly, or press and hold, until the station is received.

### 5 Store the stations in preset memory.

#### ① Press the MEMORY key. **Main unit only**

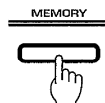
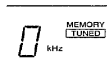

- MEMORY indicator lights up for about 5 seconds. Proceed the step ② while the MEMORY indicator is lighted.
- ② Press the numeric keys to preset the station.



Numeric keys are also available on the remote control unit.



#### Examples

To select preset No. 03, **[3]**  
 To select preset No. 10, **[+10]**, **[0]**  
 To select preset No. 20, **[+10]**, **[+10]**, **[0]**

- A total of 20 stations can be preset in memory regardless of their broadcast bands.
- If a station has been preset under the numeric key pressed, the previous preset content is replaced by the new station.
- Repeat step 2 to 5 above for each of other stations to be preset.

## Listening to a broadcast

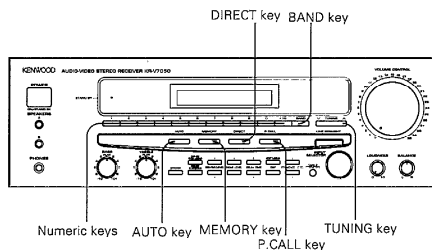

### ■ Direct tuning of radio stations

If you know the frequency of the desired station, it can be received directly by inputting the frequency using the numeric keys.

#### 1 Select the broadcast band.

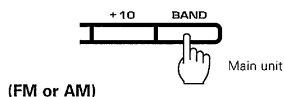

#### 2 Press the DIRECT key.

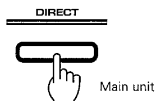

#### 3 Input the frequency of the desired station by pressing the numeric keys.

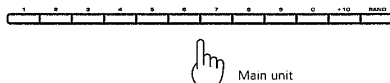

#### Example of input

Desired station	Order of pressing numeric keys	Space
FM 90 MHz	[9], [0], [0]	(100 kHz space)
FM 90 MHz	[9], [0], [0], [0]	(50 kHz space)
FM 102.5 MHz	[1], [0], [2], [5]	(100 kHz space)
FM 102.5 MHz	[1], [0], [2], [5], [0]	(50 kHz space)
AM 810 kHz	[8], [1], [0]	(9 kHz space)
AM 810 kHz	[8], [1]	(10 kHz space)
AM 1260 kHz	[1], [2], [6], [0]	(9 kHz space)
AM 1260 kHz	[1], [2], [6]	(10 kHz space)

- If you commit a mistake in the input of numeric keys, re-start the input from the beginning.

### Last channel memory

When the band selector is switched or when the input selector is switched from another source to TUNER, the last received station is recalled for each of FM, AM when the power is switched ON.

### ■ Receiving a preset station

#### 1 Select the TUNER input with the input selector.

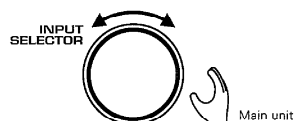

#### 2 Select the desired station.

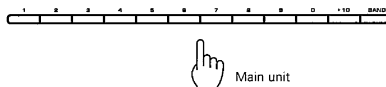

Press the numeric key under which the station is preset.

#### Example

To select preset No. 15, press the [+10] key once, then the [5] key once

- The frequency of the station received will be displayed.

### ■ Listening to all preset stations in sequence: PRESET CALL

#### Press the P.CALL key.



Preset stations are received in order of 1, 2, 3...20 every time the key on the main unit is pressed.

With the key on the remote control unit, preset stations are received in order of 1, 2,... every time the [5] key is pressed, or in order of 20, 19... every time the [0] key is pressed.

Holding one of these keys pressed recalls the preset stations in sequence at 0.5-second intervals. When the key is released, the current preset station is received.

# Operation of video components

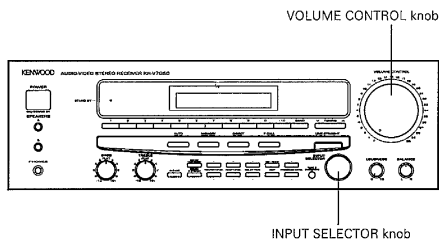

## ■ Playback of videotape

**1** Switch the power of the monitor TV ON.

**2** Select the VIDEO 1 input with the input selector.

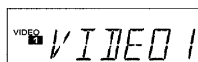

- When an input selector other than VIDEO 1, or 2 is selected, the audio input of the selected source will be played in place of the audio input from VIDEO 1.

**3** Play the VCR.

**4** Adjust the volume.

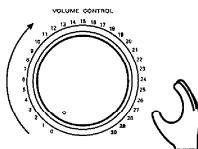

## ■ Recording of video source

**1** Connect the video equipment.

Connect the video equipment for use in audio / video recording to the VIDEO 2 jacks.

- A video player deck, video camera, LD player, DBS tuner, etc., can be connected.

**2** Select the VIDEO 2 input with the input selector.

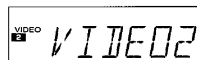
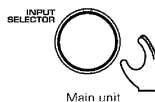

- When an input selector other than VIDEO 1 or 2 is selected, the audio input of the selected source will be played in place of the audio input from VIDEO 2.

**3** Play the video source component.

**4** Put the VCR in the record mode.

## Surround effect

The powerful feeling of enveloping sound experienced in places such as movie theaters, concert halls, and baseball stadiums is due to the fact that sound comes from not only in front but also from the periphery. To reproduce this type of feeling, this unit incorporates three types of surround decoders which are selected according to the playback source. Moreover, each presence mode employs a dedicated DSP (digital signal processor), making it possible to create a dynamic sound space without losing sound quality. To extract the maximum surround effect, read this instruction manual thoroughly and adjust the system to match the configuration of your listening room.

## Related key

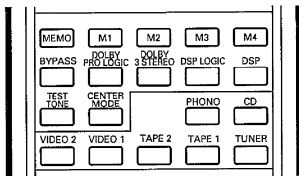

## Presence

### Dolby PRO LOGIC Surround

Videotapes and laserdiscs which bear the mark are recorded with the same Dolby surround data used in movie theaters. Since this unit incorporates a Dolby PRO LOGIC surround decoder, you can enjoy the same acoustic effects experienced in movie theaters in the comfort of your own home.

### Dolby 3 STEREO

With widely spaced left and right speakers, the center channel image for off-axis listeners shifts according to seating position. Dolby 3 Stereo localizes the center image regardless of seating position, improving the imaging over that with conventional stereo.

### DSP Presence

When playing a source such as a CD, tape, or tuner, processing the signals with high-quality digital processing provides added sound enjoyment. To create the perfect sound field for each source, this unit uses a DSP to create initial reflected sound and echoes.

### DSP LOGIC Presence

Allows to enjoy the atmosphere of a movie theater in one of two sizes; LARGE THEATER or SMALL THEATER.

Manufactured under license from Dolby Laboratories Licensing Corporation. Additionally licensed under one or more of the following patents: U.S. numbers 3,632,886, 3,746,792 and 3,959,590; Canadian numbers 1,004,603 and 1,037,877.

"Dolby" and the double-D symbol are trademarks of Dolby Laboratories Licensing Corporation.

## DSP (Digital Signal Processor)

The DSP system converts the reverberation components which enhance the presence effects into digital signals, and provides various presence effects without spoiling the quality of music sources.



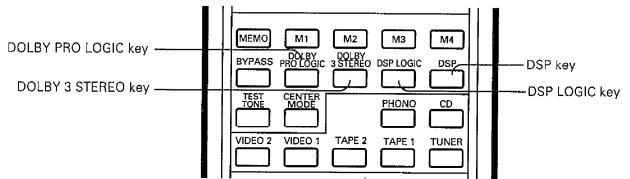

## ■ Speaker positioning

### Standard layout

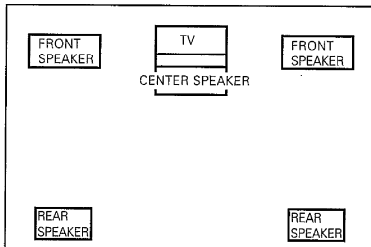

#### ① Dolby PRO LOGIC mode

Set the center mode according to the size of the center speaker.

- NORMAL** : When the center speaker size is small.  
**WIDE BAND** : When the center speaker size is large or medium.

#### ② DSP LOGIC mode

Set the center mode to "4 CH MODE" and select the desired presence mode.

### When no rear (surround) speakers are used

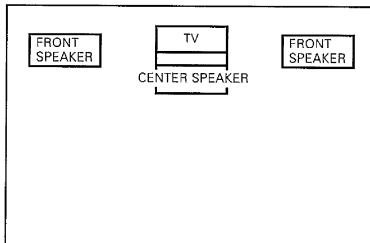

#### Dolby 3 STEREO mode

Set the center mode according to the center speaker size.

- NORMAL** : when using a small center speaker.  
**WIDE BAND** : when using a medium-sized or larger center speaker.

### When no center speaker is used

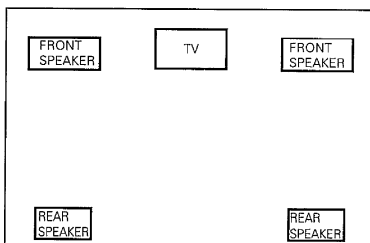

#### ① Dolby PRO LOGIC mode

Set the center mode to PHANTOM.

#### ② DSP mode

Select the desired presence mode.

#### ③ DSP LOGIC mode

Set the center mode to "3 CH MODE" and select the desired presence mode.

# Operation of Dolby PRO LOGIC playback

## ■ Dolby PRO LOGIC field adjustment

### 1 Set the Dolby PRO LOGIC mode.

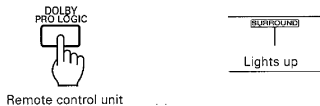

Remote control unit

### 2 Select the center mode.

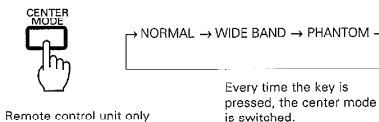

Remote control unit only

- Refer to column "Center mode" below.

### 3 Adjust the volume balance.

#### ① Press the TEST TONE key.



Remote control unit only

A buzzing sound comes from the speaker. It is switched every one and half second for each other.

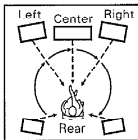

- Press at the listening position.

In **NORMAL** or **WIDE BAND** mode:

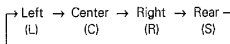

In **PHANTOM** mode:

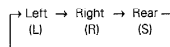

### ② Adjust the volume balance.

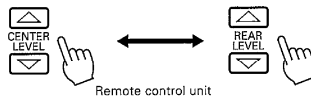

Remote control unit

- Adjust so that the test tone volumes are the same on all speakers.
- The level being adjusted is displayed.
- The center level cannot be adjusted in the PHANTOM mode.

### 4 Stop generating the test tone.



Remote control unit only

### 5 Set the delay time.



Remote control unit



- Calculate the proper delay time for Dolby Surround by referring to the illustration below.
- The delay time can be adjusted in the range from 16 to 29 ms.
- When the DELAY TIME key is pressed a delay time appears on the display. It varies every time the key is pressed.  
16ms ↔ 20ms ↔ 23ms ↔ 26ms ↔ 29ms
- Once a delay time is set, it is automatically held in memory so the same delay time is displayed whenever Dolby Surround is switched ON later.

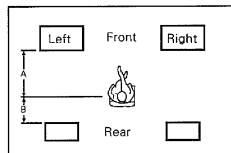

Delay time (ms) = 20 ms + 3 ms (A - B)  
A : Distance of front speaker (m)  
B : Distance of rear speaker (m)

## Center mode

Select one of the following center modes according to the type of the presence speakers in your system.

**NORMAL** : Use this mode with a center speaker of a compact size.

**WIDE BAND** : Use this mode with a center speaker of a medium or larger size.

- If you cannot identify whether your center speaker is of the medium or compact size, try both the NORMAL and WIDE BAND mode and use the one that can provide better sound positioning.

**PHANTOM** : Use this mode when the center speaker is not used.

- Even without the center speaker, the signal is processed in a simulated manner to ensure proper center image positioning and provide the enjoyment of Dolby Surround.



Every time the key is pressed, the center mode is switched.

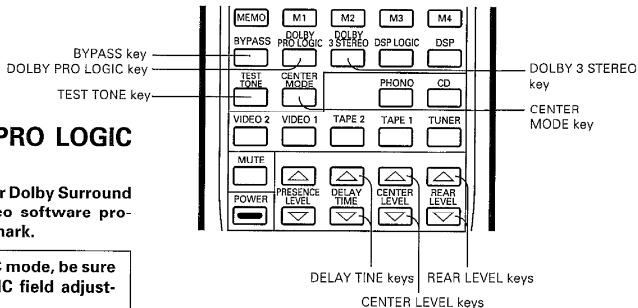

## ■ Operation of Dolby PRO LOGIC playback

This function allows to enjoy a similar Dolby Surround effect to movie theaters from video software programs carrying the mark.

Before using the Dolby PRO LOGIC mode, be sure to perform the "Dolby PRO LOGIC field adjustment" procedure.

### 1 Set the Dolby PRO LOGIC mode.

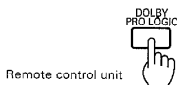

Lights up.

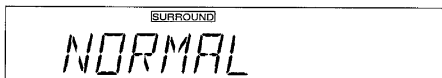

### 2 Select the center mode.

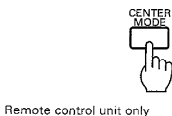

- Select the mode which has been set in step 2 of the "Dolby PRO LOGIC field adjustment" procedure. (Refer to page 26.)

Every time the key is pressed, the center mode is switched.

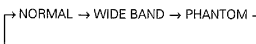

### 3 Play a software program encoded with Dolby Surround.

### 4 Adjust the volume and tone.

- When the level balance of center and rear speakers is not good, perform the "Dolby PRO LOGIC field adjustment" procedure again.

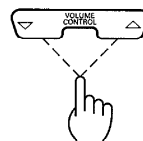
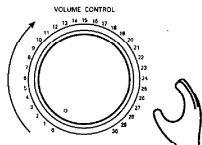

### To return to normal stereo playback.

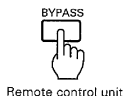

Goes off

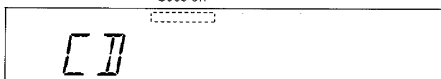

# Dolby 3 STEREO Mode

The Dolby 3 STEREO provides an active center channel to produce a better, stable center image. This mode can be used when listening to stereo video program and music or when surround listening or surround system set-up not possible.

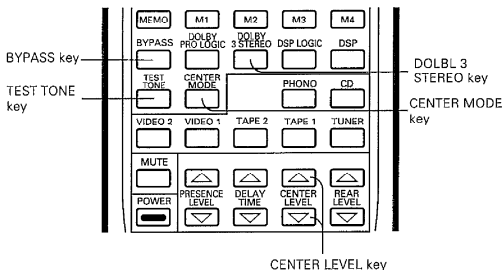

## ■ Dolby 3 STEREO adjustment

### 1 Set the Dolby 3 STEREO mode.



Remote control unit

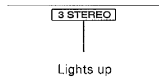

### 2 Select the center mode.

Every time the key is pressed, the center mode is switched.

NORMAL ↔ WIDE BAND

- Set the center mode to NORMAL if using a small center speaker, or set to WIDE BAND if using a medium-sized or larger speaker.



Remote control unit only

### 3 Adjust the center speaker volume.

#### ① Press the TEST TONE key.



Remote control unit only

A buzzing sound comes from the speaker. It is switched every one and half second for each other.

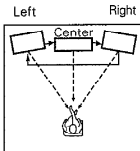

- Press at the listening position.
- When at 3 stereo sound is produced in the sequence: LEFT → CENTER → RIGHT (REAR not available with 3 stereo mode.)

#### ② Adjust the volume.



Remote control unit

- And adjust so that the level of the center speaker is equal to that of the left and right speakers.
- The rear level adjustment is invalid.

### 4 Stop generating the test tone.

Press the key again.



Remote control unit only

## ■ Dolby 3 STEREO playback

### 1 Set the Dolby 3 STEREO mode.



Remote control unit

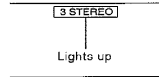

### 2 Select the center mode.

Every time the key is pressed, the center mode is switched.

NORMAL ↔ WIDE BAND

- Set the center mode to NORMAL if using a small center speaker, or set to WIDE BAND if using a medium-sized or larger speaker.



Remote control unit only

### 3 Play a stereo software program or a Dolby surround program.

### 4 Adjust the volume and tone.

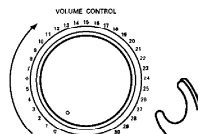

Main unit

### To return to normal stereo playback.



Remote control unit

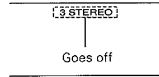

Goes off

# DSP / DSP LOGIC Presence

The DSP (Digital Signal Processor) allows to reproduce the atmospheres of various sound fields. By applying additional adjustments, a custom presence effect of yourself can also be created.

- ① DSP presence modes.....ARENA, JAZZ CLUB, STADIUM, DISCOTHEQUE
- ② DSP Logic presence modes ...LARGE THEATER, SMALL THEATER

Satisfactory effect can be enjoyed by selecting one of the presence modes by referring to the table below. Additionally, the parameters shown in the table can also be adjusted according to your liking.

Presence level : Variable in the range from - 20 to 0 dB.  
 Delay time : Variable in the range from 3 to 50 ms.  
 Rear level : Variable in the range from - 30 to + 10 dB.  
 Center level : Variable in the range from - 30 to + 10 dB.

Presence mode	Initial setting values			Variable setting values	
	CHANNEL MODE	DELAY TIME	PRESENCE LEVEL	CENTER LEVEL	REAR LEVEL
ARENA	*	10 ms	- 12 dB	*	- 30 dB~ + 10 dB
JAZZ CLUB	*	16 ms	- 12 dB	*	- 30 dB~ + 10 dB
STADIUM	*	26 ms	- 8 dB	*	- 30 dB~ + 10 dB
DISCOTHEQUE	*	16 ms	- 8 dB	*	- 30 dB~ + 10 dB
LARGE THEATER	3ch	32 ms	- 8 dB	*	- 30 dB~ + 10 dB
	4ch	32 ms	- 8 dB	- 30 dB~ + 10 dB	- 30 dB~ + 10 dB
SMALL THEATER	3ch	16 ms	- 16 dB	*	- 30 dB~ + 10 dB
	4ch	16 ms	- 16 dB	- 30 dB~ + 10 dB	- 30 dB~ + 10 dB

ARENA..... A hall where high frequencies are reflected very well and reverberations are long.

JAZZ CLUB ..... A live house of jazz where cymbals sounds well.

STADIUM ..... A stadium with reflections proper to PA speakers.

DISCOTHEQUE ..... A disco where medium-frequency range is enhanced by comfortable reverberations.

LARGE THEATER ..... Reproduces a surround sound proper to a large movie theater.

SMALL THEATER ..... Reproduces the sound field of a small movie theater or hall.

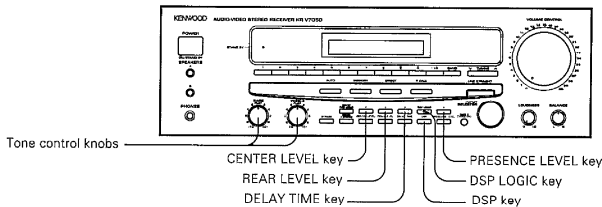

## ■ Creating a DSP sound field

### 1 Select the presence mode.

Main unit or Remote control unit

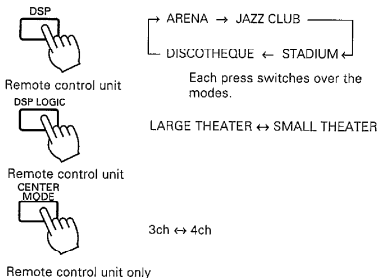

- Press the CENTER MODE key only in the DSP LOGIC mode.

### 2 Play the music source.

Now, a sufficient sound field effect of the presence mode can be obtained. However, you can make additional adjustments as described in the following.

- Even when the following presence parameters have been adjusted, they will return to the initial settings when the Dolby Surround mode or another presence mode is selected.

### 3 Adjust the presence level.

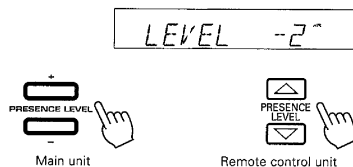

- Set in 2 dB steps within a range of -20 to 0 dB.

### 4 Adjust the volume.

#### ① Adjust the center level.

- Set within a range of -30 to +10 dB.



#### ② Adjust the rear level.

- Set within a range of -30 to +10 dB.



- Perform step ① only when the DSP LOGIC mode is set to "4 CH MODE".

### 5 Adjust the sound quality. **Main unit only**

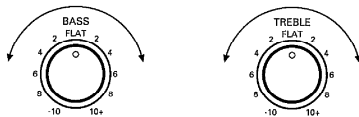

### 6 Set the delay time.



- The delay time can be adjusted within a range of 3 ms to 50 ms.

# Surround Information Memory

## Surround information memory functions

For the enjoyment in Surround modes, it is required to set the levels of the channels, delay time, etc., as described on pages 29, 30, 31, 32, and 33. The Surround information memory function makes it possible to store such information in memory.

The Surround Information Memory function allows to store up to four sets of Surround information.

SURROUND M1-M4 keys

MEMO key

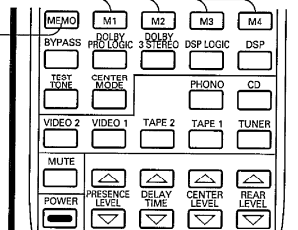

## ■ How to save Surround setup in memory Remote control unit only

### 1 Select or create the surround setup to be saved.

- BYPASS cannot be stored.

### 2 Press the MEMO key.

- Proceed to the step 3 while the display shown right is lighted.
- The unit enters storing stand by mode.



### 3 Press the M1 ~ M4 key.

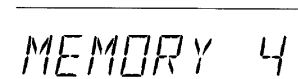
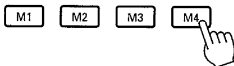

- Set to M1-M4.

## ■ How to recall a Surround setup Remote control unit only

To recall a pattern from the Surround memory, Press one of the M1 to M4 keys to recall a pattern directly from the Surround memory.

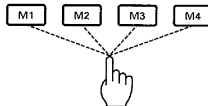

# In case of difficulty

What appears to be a malfunction may not always be serious. If your unit should not perform as expected, consult the table below to see if the problem can be corrected before seeking help from your dealer or service representative.

## Remote control unit

Symptom	Cause	Remedy
Remote control operation is not possible.	<ul style="list-style-type: none"> <li>● Batteries are exhausted.</li> <li>● The audio cords and the system control cords are not connected properly.</li> <li>● The remote control unit is too far away from the main system, controlling angle is too large, or there is an obstacle in between.</li> <li>● The source component to be operated does not contain the analog disc, tape(s) or CD.</li> <li>● An attempt is made to play a tape which is being recorded in the cassette deck.</li> </ul>	<ul style="list-style-type: none"> <li>● Replace with new batteries.</li> <li>● Connect properly referring to "System connections".</li> <li>● Operate the remote control unit within the controllable range.</li> <li>● Place an analog disc, tape(s) or CD in the source component to be played.</li> <li>● Wait until the recording is completed.</li> </ul>

## Amplifier, speakers

Symptom	Cause	Remedy
Sound is not output.	<ul style="list-style-type: none"> <li>● The speaker cords are disconnected.</li> <li>● The volume is set to the minimum position.</li> <li>● The MUTE key is set to ON and the point indicator is blinking.</li> </ul>	<ul style="list-style-type: none"> <li>● Connect them properly referring to "System connections".</li> <li>● Adjust the volume to a proper level.</li> <li>● Press the MUTE key to OFF.</li> </ul>
No sound comes out, and "PROTECT" is shown on the display.	<ul style="list-style-type: none"> <li>● Speaker cords are short-circuited.</li> </ul>	<ul style="list-style-type: none"> <li>● Turn the power off, eliminate the short-circuiting, then turn on the power again.</li> </ul>
Sound is not output from one of the speakers.	<ul style="list-style-type: none"> <li>● The speaker cord is disconnected.</li> <li>● The BALANCE control is set to an extreme position.</li> </ul>	<ul style="list-style-type: none"> <li>● Connect it properly referring to "System connections".</li> <li>● Adjust the Left / Right balance.</li> </ul>
Sound is not output from the surround rear speaker and / or center speaker, or their sound is very small.	<ul style="list-style-type: none"> <li>● The rear speaker cords and / or center speaker cord are disconnected.</li> <li>● The presence mode has not been engaged.</li> <li>● The REAR LEVEL and / or CENTER LEVEL controls are set to the minimum level.</li> </ul>	<ul style="list-style-type: none"> <li>● Connect them properly referring to "System connections".</li> <li>● Set the presence mode.</li> <li>● Adjust the REAR LEVEL and CENTER LEVEL controls.</li> </ul>
A hum noise is generated when the PHONO input is selected.	<ul style="list-style-type: none"> <li>● The audio cord from the turntable is not inserted securely into the PHONO jacks.</li> <li>● The turntable is not grounded.</li> </ul>	<ul style="list-style-type: none"> <li>● Insert the audio cord plugs securely into the PHONO jacks.</li> <li>● Connect the grounding wire to the GND terminal on the rear panel.</li> </ul>



## Tuner

Symptom	Cause	Remedy
Radio stations cannot be received.	<ul style="list-style-type: none"><li>● No antenna is connected.</li><li>● The broadcast band is not set properly.</li><li>● The frequency of the desired station is not tuned.</li></ul>	<ul style="list-style-type: none"><li>● Connect an antenna.</li><li>● Set the broadcast band properly.</li><li>● Tune the frequency of the desired station.</li></ul>
A station which was preset cannot be received by pressing the corresponding numeric key.	<ul style="list-style-type: none"><li>● The preset station belongs to a frequency that cannot be received.</li><li>● The preset memory was cleared because the power cord had been unplugged for a long period of time.</li></ul>	<ul style="list-style-type: none"><li>● Preset a station with a receivable frequency.</li><li>● Preset the station again.</li></ul>
Interference.	<ul style="list-style-type: none"><li>● Noise due to ignition noise of an automobile.</li><li>● Noise due to an influence from an electric appliance.</li><li>● Noise due to a nearby TV set.</li></ul>	<ul style="list-style-type: none"><li>● Install the outdoor antenna apart from the road.</li><li>● Turn off the power of the appliance.</li><li>● Install the system more apart from the TV set.</li></ul>

### For the U.S.A. FCC WARNING

This equipment may generate or use radio frequency energy. Changes or modifications to this equipment may cause harmful interference unless the modifications are expressly approved in the instruction manual. The user could lose the authority to operate this equipment if an unauthorized change or modification is made.

#### NOTE:

This equipment has been tested and found to comply with the limits for a Class B digital device, pursuant to Part 15 of the FCC Rules. These limits are designed to provide reasonable protection against harmful interference in a residential installation. This equipment may cause harmful interference to radio communications, if it is not installed and used in accordance with the instructions. However, there is no guarantee that interference will not occur in a particular installation. If this equipment does cause harmful interference to radio or television reception, which can be determined by turning the equipment off and on, the user is encouraged to try to correct the interference by one or more of the following measures:

- Reorient or relocate the receiving antenna.
- Increase the separation between the equipment and receiver.
- Connect the equipment into an outlet on a circuit different from that to which the receiver is connected.
- Consult the dealer or an experienced radio / TV technician for help.

### For the U.S.A. Note to CATV system installer:

This reminder is provided to call the CATV system installer's attention to Article 820-40 of the NEC that provides guidelines for proper grounding and, in particular, specifies that cable grounding shall be connected to the ground system of the building, as close to the point of cable entry as practical.

#### Notes:

1. This system is microprocessor-controlled, so malfunction may occur due to external noise or interference noise. In such a case, unplug the power cord, plug it again keeping the POWER key pressing. (In this case, all the memories are cleared.)
2. Do not use contact cleaners because it could cause a malfunction. Be specially careful against contact cleaners containing oil, for they may deform the plastic components.

# Specifications

⚠ Caution: Read this page carefully to ensure safe operation.

(For U.S.A. and Canada)

## Audio section

Rated power output at the STEREO operation

100 watts per channel minimum RMS, both channels driven at 8 Ω, from 20 Hz to 20,000 Hz with no more than 0.06% total harmonic distortions. (FTC)

Power output at the Surround operation

Front (1 kHz, 0.9% T.H.D. at 8 Ω) ..... 65 W + 65 W  
Center (1 kHz, 0.9% T.H.D. at 8 Ω) ..... 65 W  
Rear (1 kHz, 0.9% T.H.D. at 8 Ω) ..... 20 W + 20 W

Total harmonic distortion (1 kHz, 8 Ω) .... 0.03% at 50 W  
Signal to noise ratio (IHF A)

PHONO (MM) ..... 78 dB  
CD, TAPE, VIDEO ..... 100 dB

Input sensitivity / impedance

PHONO (MM) ..... 2.5 mV / 47 kΩ  
CD, TAPE, VIDEO ..... 200 mV / 47 kΩ

Tone controls

BASS ..... ±10 dB (at 100 Hz)  
TREBLE ..... ±10 dB (at 10 kHz)

Loudness control at -30 dB VOLUME level

..... 0 ~ +8 dB (100 Hz)

## Video section

VIDEO inputs / outputs(Composite) ..... 1 Vp-p / 75 Ω

## FM Tuner section

Tuning frequency range ..... 87.5 MHz~108 MHz

Usable sensitivity (IHF) ..... 10.8 dBf (0.95 μV at 75 Ω)

50 dB quieting sensitivity

MONO ..... 17.2 dBf (2.0 μV at 75 Ω)  
STEREO ..... 41.2 dBf (32 μV at 75 Ω)

Total harmonic distortion at 1 kHz

MONO ..... 0.4%  
STEREO ..... 0.5%

Signal to noise ratio at 65 dBf (IHF)

MONO ..... 78 dB  
STEREO ..... 73 dB

Selectivity (IHF ±400 kHz) ..... 53 dB

Stereo separation (IHF at 1 kHz) ..... 45 dB

Frequency response .. 30 Hz-15 kHz, +0.5 dB,-2.0 dB

## AM Tuner section

Tuning frequency range ..... 530 kHz~1,700 kHz

Usable sensitivity ..... 12 μV / (400 μV / m)

Total harmonic distortion ..... 0.3 %

Signal to noise ratio ..... 50 dB

Selectivity ..... 30 dB

## General

Power consumption ..... 3 A

AC outlet

SWITCHED ..... 2: (total 200 W, 1.6 A max.)

Dimensions ..... W:440 mm (17-5/16")

H:147 mm (5-13/16")

D:403 mm (15-7/8")

Weight (net) ..... 11.4 kg (25.1 lb)

(For other countries)

## Audio section

Rated power output at the STEREO operation

(IHF '66) from 20 Hz to 20 kHz,

0.06% T.H.D., at 8 Ω ..... 100 W + 100 W

Power output at the Surround operation

Front (1 kHz, 0.9% T.H.D. at 8 Ω) ..... 65 W + 65 W

Center (1 kHz, 0.9% T.H.D. at 8 Ω) ..... 65 W

Rear (1 kHz, 0.9% T.H.D. at 8 Ω) ..... 20 W + 20 W

Total harmonic distortion (1 kHz, 8 Ω) 0.03% at 50 W

Signal to noise ratio (IHF'66)

PHONO (MM) ..... 78 dB

CD, TAPE, VIDEO ..... 100 dB

Input sensitivity / impedance

PHONO (MM) ..... 2.5 mV / 47 kΩ

CD, TAPE, VIDEO ..... 200 mV / 47kΩ

Tone controls

BASS ..... ±10 dB (at 100 Hz)

TREBLE ..... ±10 dB (at 10 kHz)

Loudness control at -30 dB VOLUME level

..... 0 ~ +8 dB (100 Hz)

## Video section

VIDEO inputs / outputs(Composite) ..... 1 Vp-p / 75 Ω

## FM Tuner section

Tuning frequency range ..... 87.5 MHz~108 MHz

Usable sensitivity (IHF) ..... 10.8 dBf (0.95 μV at 75 Ω)

50 dB quieting sensitivity

MONO ..... 17.2 dBf (2.0 μV at 75 Ω)

STEREO ..... 41.2 dBf (32 μV at 75 Ω)

Total harmonic distortion at 1 kHz

MONO ..... 0.4 %

STEREO ..... 0.5 %

Signal to noise ratio at 65 dBf (IHF)

MONO ..... 78 dB

STEREO ..... 73 dB

Selectivity (IHF ±400 kHz) ..... 53 dB

Stereo separation (IHF at 1 kHz) ..... 45 dB

Frequency response . 30 Hz~15 kHz, +0.5 dB,-2.0 dB

## AM Tuner section

Tuning frequency range

9 kHz ..... 531 kHz ~ 1,602 kHz

10 kHz ..... 530 kHz ~ 1,610 kHz

Usable sensitivity ..... 12 μV / (400 μV / m)

Total harmonic distortion ..... 0.3 %

Signal to noise ratio ..... 50 dB

Selectivity ..... 30 dB

## General

Power consumption ..... 280 W

AC outlet

SWITCHED ..... 2: (total 200 W max.)

(Except for Australia)

Dimensions ..... W:440 mm

H:147 mm

D:403 mm

Weight (net) ..... 11.4 kg

Note:

KENWOOD follows a policy of continuous advancements in development. For this reason specifications may be changed without notice.

KENWOOD